

1 GARAGE LEVEL 1 FLOOR PLAN

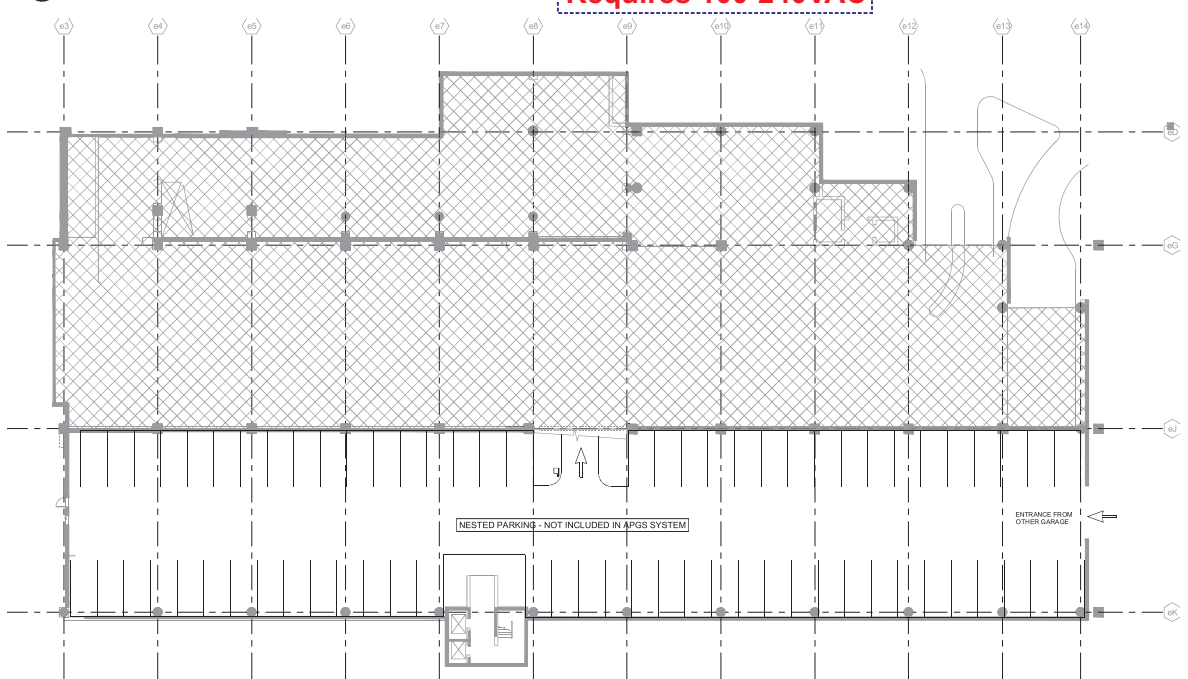

2 GARAGE BASEMENT LEVEL PLAN

PGS - Wiring Details

- (Comm. Bus/24VDC) - 2 pairs of 18 AWG
- Orange Line** (Comm. Bus/24VDC) - 3 pairs of 18 AWG
- Blue Line** (Sensor Bus 0) - 2 pairs of 18 AWG
- Red Line** (Sensor Bus 1) - 2 pairs of 18 AWG
- Green Line** (Sensor Bus 2) - 2 pairs of 18 AWG
- Yellow Line** Cat5e or Better Ethernet

PGS -Details

- Single Space Sensor
- Wireless Single Space Sensor
- CP Communication point
CP Enclosures Require 100-240 VAC Power
- GW Gateway for wireless communication
GW Enclosures Require 100-240 VAC Power and Ethernet (Cat5e or Better)
- DS# Dynamic Sign

TCS International
55 Union Avenue
Sudbury, MA 01776
Phone (978) 443-2527
Fax (978) 579-9545
www.tcsintl.com



BXP Green Garage Level Basement & 1

Customer: Provided Drawing C-201

Drawing No. _____

Submittal No. _____

Submittal Date _____

Rev	REV 1.1
Engineer	AB
Draftsman	10/28/2022
Date	-
Checked	-
Approved	-

PGS Design Approved by Customer

Customer Signature _____

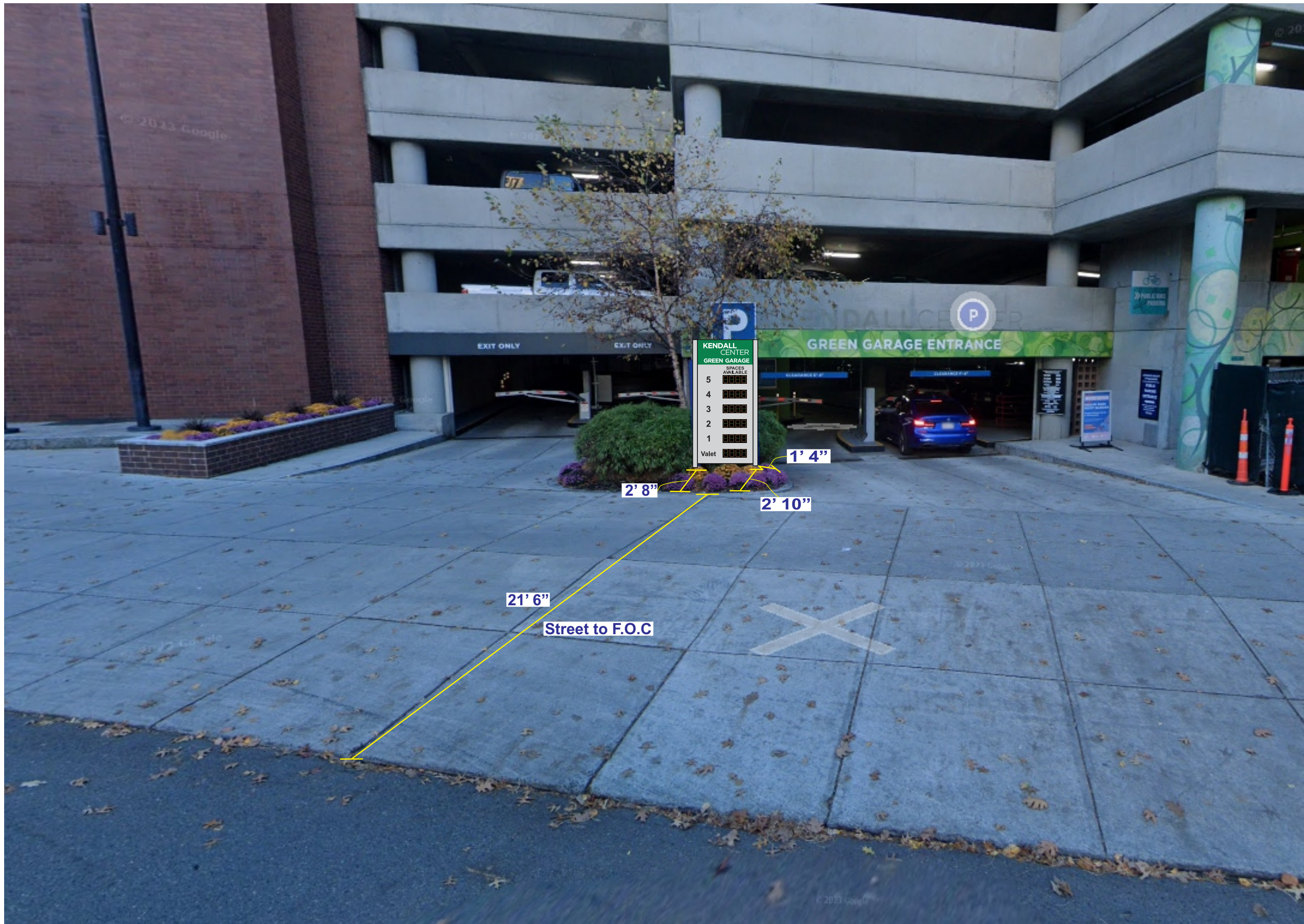

KENDALL
CENTER
GREEN GARAGE

SPACES
AVAILABLE

5 0000

4 0000

3 0000

2 0000

1 0000

Valet 0000

2' 8"

1' 4"

2' 10"

21' 6"

Street to F.O.C

PGS Design Approved by Customer

Rev	REV 1
Engineer	AB
Draftsman	AB
Date	09/14/2023
Checked	-
Approved	-

BXP Green Garage Entrance Sign		Submittal No.	
		Submittal Date	
Drawing No.		Submittal No.	
		Submittal Date	

TCS International
55 Union Avenue
Sudbury, MA 01776
Phone (978) 443-2527
Fax (978) 579-9545
www.tcsiintl.com

TCS International

Customer Signature _____



PROPOSED SIGNAGE

Drawing No: 12195 Sheet 1 of 4 Date: 11-08-22
 Revised: 09-07-23 Scale: Noted
 Drawn By: Andrew Mehler

TCS -BPX Kendall Square Green Garage

55 Union Avenue
 Sudbury, MA 01776
 978-443-2527
 www.tcsintl.com



BPX KENDALL SQUARE GREEN GARAG

DS1 6 LEVEL MASTER PANEL MONUMENT SIGN - SINGLE FACED QTY:1

**OPTION 2:
ANCHOR BOLTS
& MOUNTING PLATES**

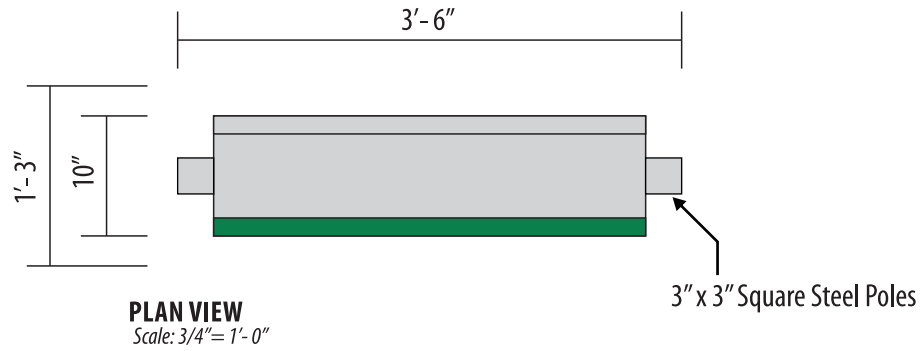

PAINT COLORS:

- BOTTOM REVEAL TO BE PAINTED w/ MATTHEWS PAINT TO MATCH PMS COOL GRAY 11C
- BACKGROUND & POLES TO BE PAINTED MATTHEWS BRUSHED SILVER
- ACCENT COLOR TO BE PAINTED w/ MATTHEWS PAINT TO MATCH PANTONE PMS 348C

VINYL:

- LETTERING TO BE PRECISION CUT BLACK REFLECTIVE VINYL TO MATCH
- LETTERING TO BE PRECISION CUT WHITE REFLECTIVE VINYL

Font Used: Arial Bold - Gotham Bold / Book

APPROVED BY: _____

DATE: _____

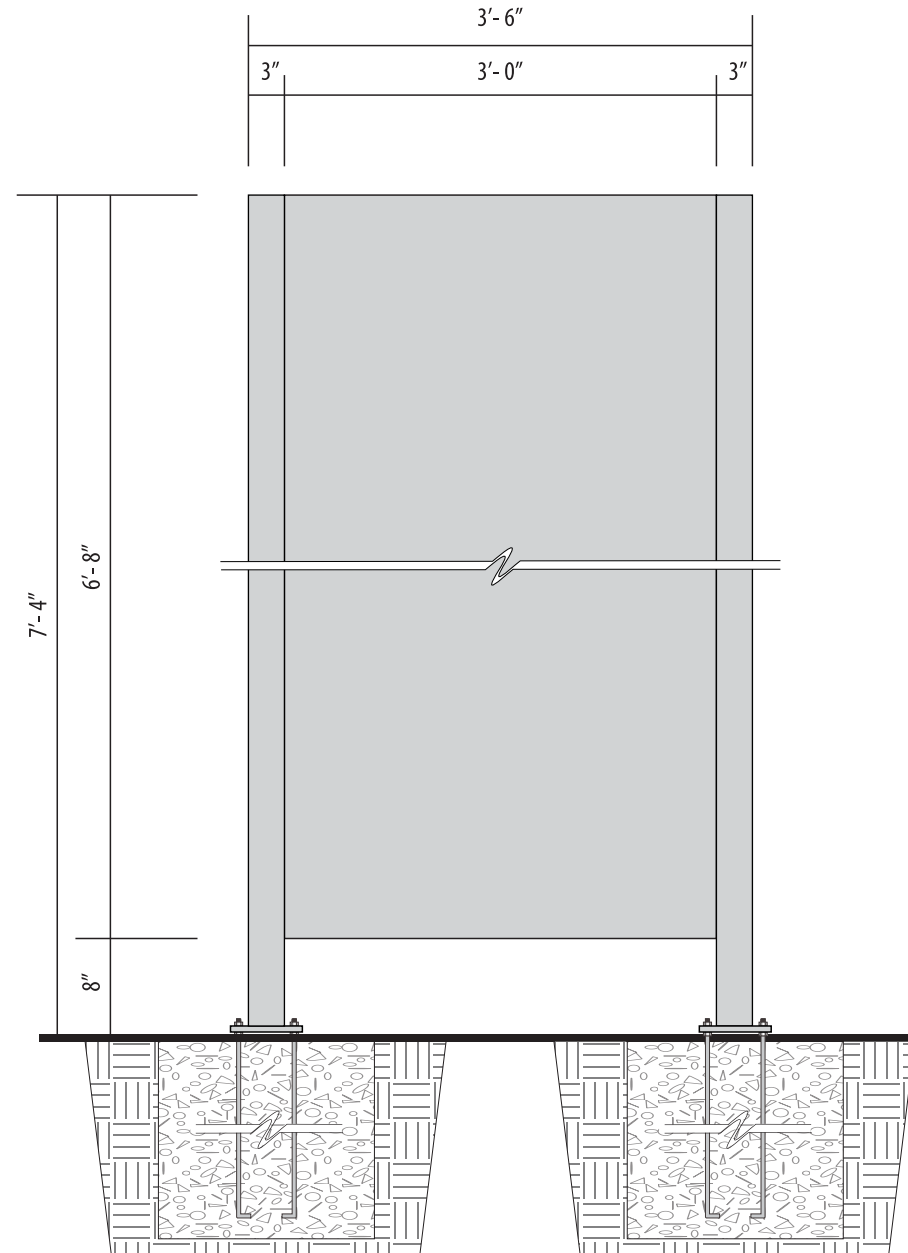
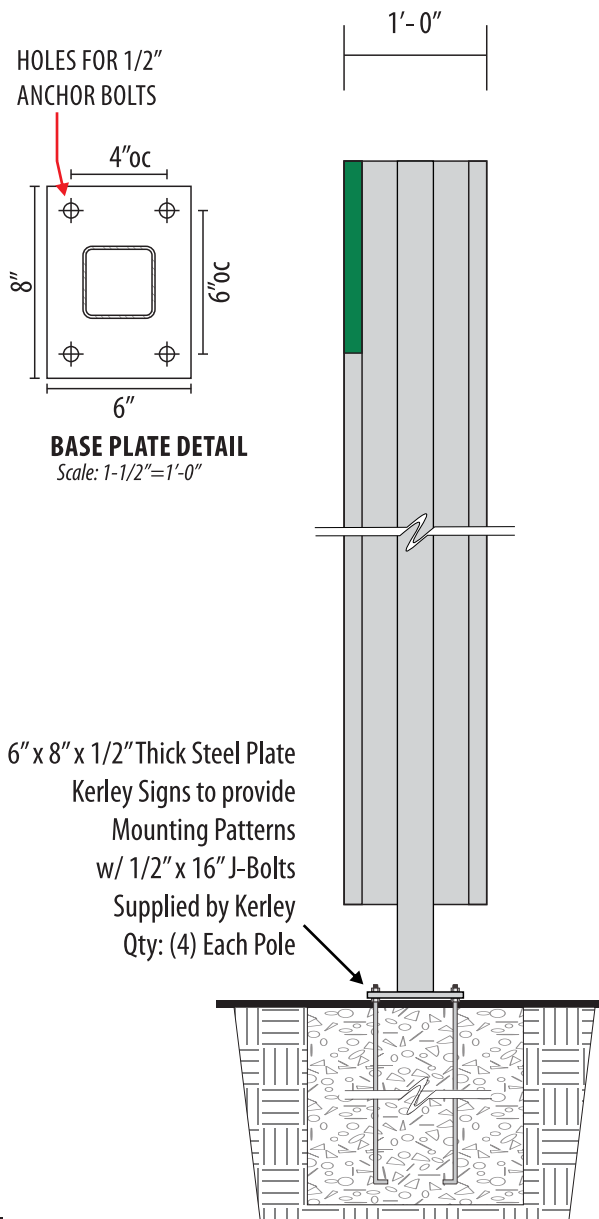
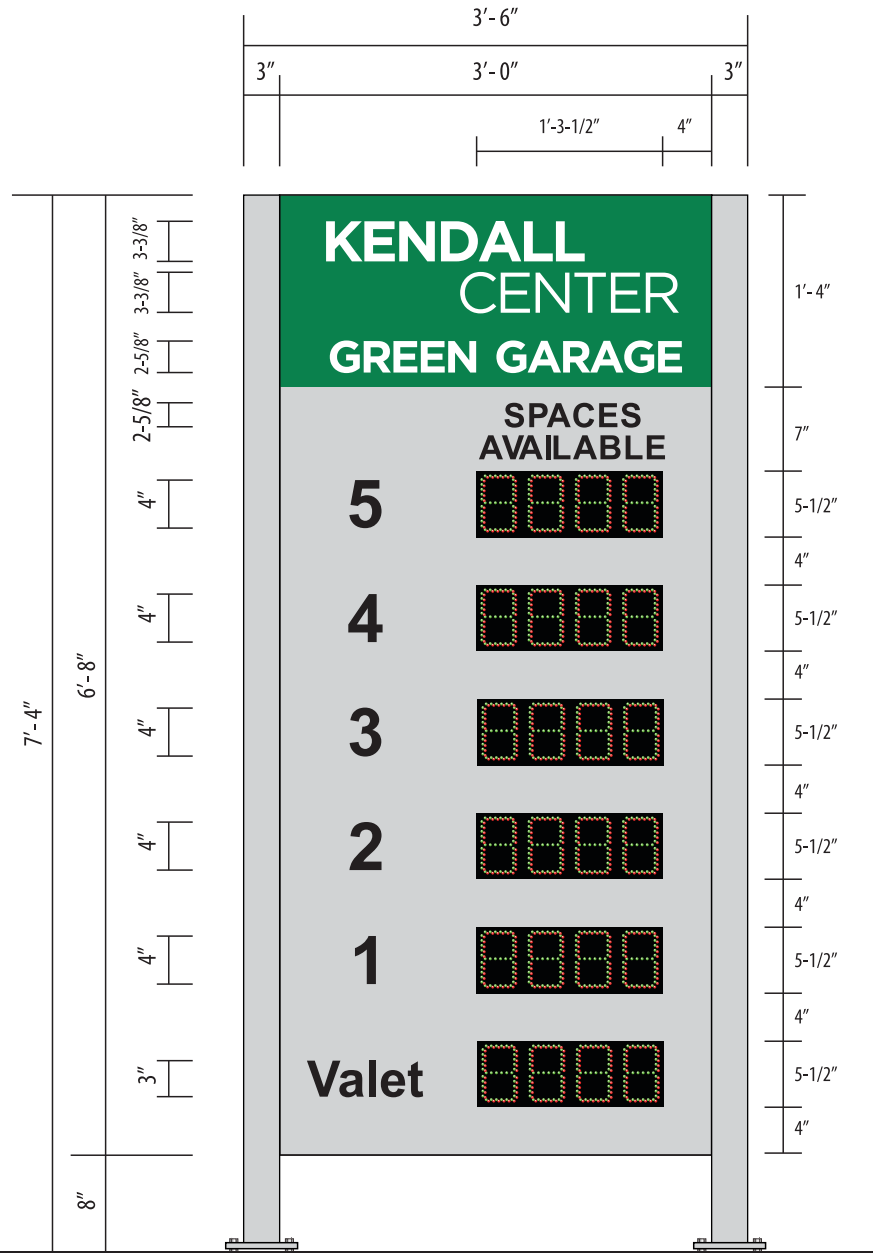
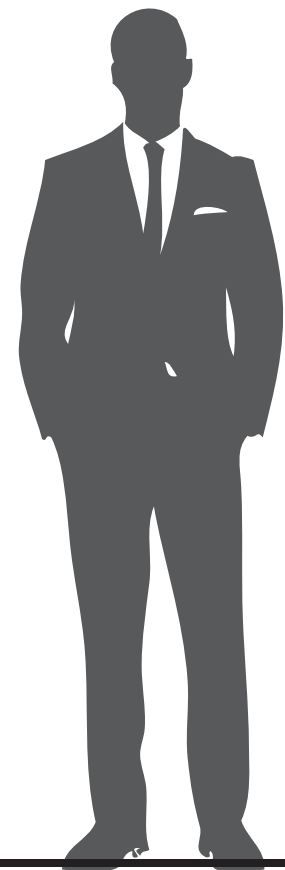

Drawing No: 12195 Sheet 3 of 4 Date: 11-08-22
Revised: 09-07-23 Scale: Noted
Drawn By: Andrew Mehler

TCS - BPX Kendall Square Green Garage

55 Union Avenue
Sudbury, MA 01776
978-443-2527
www.tcsintl.com



*Engineering if needed will be additional

4 DIGIT LED INSERT

PRODUCT NUMBER
TMS-54DF

DIMENSIONS
Frame 8.35" H x 17.8" W x 1.52" D
Viewable window 6.1" H x 15" W

ILLUMINATION SOURCE
Super bright, wide viewing angle LEDs
Available in green & red LEDs
Viewing angle 40°/130°
Long life, solid state lighting
Automatic brightness adjustment

ELECTRICAL
24 VDC Low Voltage
Full brightness is 0.35 Amps max
Conformal coating
QPS Certified

CONSTRUCTION
Single sided extruded aluminum cabinet
Aluminum unfinished
Impact resistant poly carbonate lense w/ dimensions of 18.6"W x 8.096" H

DISCLAIMER
Q-Free will not warrant LED displays used in 3rd party cabinets when failure is due to cabinet integrity, moisture, condensation or leakage determined at Q-Free discretion.

Product View

NOTE: Sign image may not exactly represent the finished product. For illustration purposes only.



MESSAGE	LED COLOR	HEIGHT	AMPS
4 DIGIT 7 SEGMENT DISPLAY	40° x 100° Green Oval	5.0"	0.3
OPEn	40° x 100° Green Oval	5.0"	0.3
CLOSEd (scrolling)	40° x 100° Green Oval	5.0"	0.3
FULL	40° x 100° Red Oval	5.0"	0.3

Drawing No: 12195 Sheet 4 of 4 Date: 11-08-22
Revised: 09-07-23 Scale: Noted
Drawn By: Andrew Mehler

TCS - BPX Kendall Square Green Garage

55 Union Avenue
Sudbury, MA 01776
978-443-2527
www.tcsintl.com

